

# Dune BD Prime

Quick guide

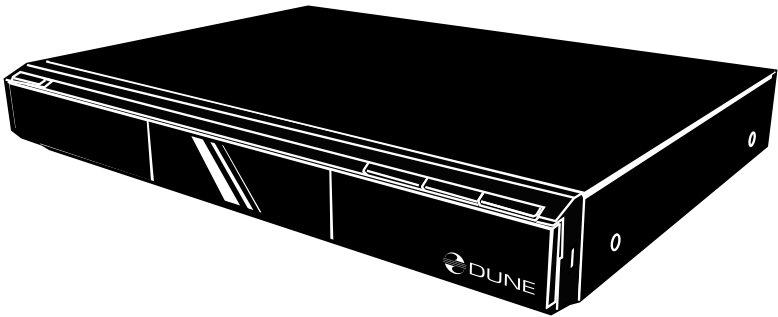

# Key features of DUNE HD Prime media player:

## Blu-Ray video playback support

- BD-ROM (Profile 1.1/2.0)

## Built in Mediacenter

- Media files playback support

## External Sources support:

- USB mass storage devices (USB HDD, USB flash memory)
- NFS network folders
- SMB network folders
- HTTP URLs (limited support)

## Compact and modern look slim case

### HDMI v1.3

- State-of-the-art HDMI v1.3 ensures excellent quality of digital video and audio signals

### Three USB 2.0 ports

- Three high-speed USB 2.0 ports ensure easy playback of media content from external data storage devices like USB-HDD, flash drives, card-readers, etc.

### Built in 7.1 channel decoder

- The player may be directly connected to external multi channel amplifier

### Optical and coaxial digital audio output

- The player may be connected to an AV-receiver for transmission of multi-channel digitalized audio signal

### Upgradeable

- Installation of the optional modules is accessible: Wi-Fi 802.11n, Ethernet 1000 Mb/s, 2 x eSATA

## Exterior

### Front view

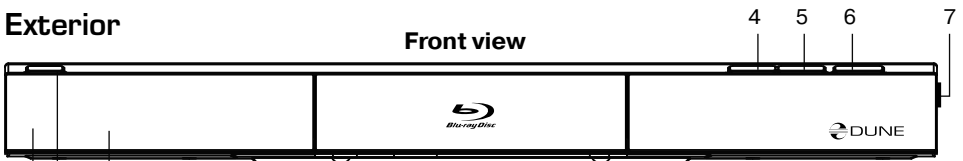

- |                      |                         |            |                |                |                      |  |
|----------------------|-------------------------|------------|----------------|----------------|----------------------|--|
| 1                    | 2                       | 3          | 4              | 5              | 6                    | 7  |
| 1. Standby Indicator | 2. POWER/STANDBY Button | 3. Display | 4. STOP Button | 5. PLAY Button | 6. OPEN/CLOSE Button | 7. USB Jack (on side of unit, under compartment) |

### Rear view

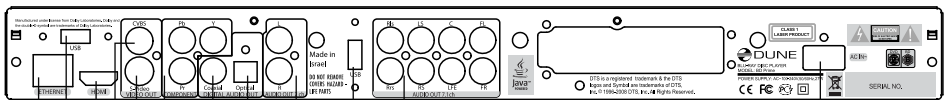

- |        |            |              |                             |                        |   |                        |                        |   |                                    |                   |
|--------|------------|--------------|-----------------------------|------------------------|---|------------------------|------------------------|---|------------------------------------|-------------------|
| 1      | 2          | 3            | 4                           | 5                      | 6   | 7                      | 8                      | 9                                       | 10                                 | 11                |
| 1. LAN | 2. USB 2.0 | 3. HDMI Jack | 4. Video Output (CVBS) Jack | 5. S-Video Output Jack | 6. Component Video (Y, Pb, Pr) Output Jacks | 7. COAXIAL Output Jack | 8. OPTICAL Output Jack | 9. Stereo Audio Left/Right Output Jacks | 10. 7.1 Channel Audio Output Jacks | 11. AC Power Jack |

## Package contents:

1. Dune BD Prime media player
2. Remote control (batteries not included)
3. Power supply cord
4. AV cable
5. Quick start guide

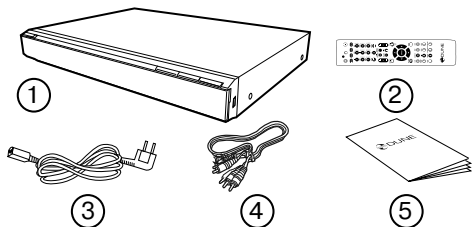

## Safety measures:

To avoid troubles, before to start using this device, please read this quick guide carefully and keep it for future reference.



**Warning:** This Blu-ray player uses a laser beam sightless with human eye. If directed to human eye retina, it may cause hazardous radiation exposure and loss of sight. Please make sure that you use the player in conformity with the user's manual. Please make sure that the device is out of reach of small children as far as possible.



**Caution:** This product employs a laser system. Performing adjustments, or carrying out procedures other than those specified herein may result in hazardous radiation exposure. Do not open the safety enclosure: this product does not contain any parts that can be repaired by the user.

- 1) Do not try to repair the device. Only authorized after-sales centers are entitled to carry out repair and preventive maintenance.
- 2) To avoid electric shock, do not touch the plugged in device with wet hands and do not allow moisture within the case. If it happened, immediately unplug the device and contact an authorized Dune service center.
- 3) Clean the device only with a dry soft cotton, or alike, cloth preventing accumulation of static discharges. Do not use any liquid detergent or scouring powder. In case of hard dirt, use special wipes suitable for PC care. Make sure that the wipe is dry enough (otherwise fluid drops may get inside).
- 4) The device is for indoor use only. Do not expose it to direct sunlight, do not leave it near a heater or radiator.
- 5) DO NOT use the device in rooms with high humidity.
- 6) DO NOT plug in the player immediately after moving it from a cold into a warm place. If you move the device from an extremely cold place, unpack it and leave for 1.5 to 2 hours in order to allow evaporation of condensate on internal parts, afterwards you may start using it.
- 7) Please make sure to switch off all relevant AV equipment before connection to the Blu-ray media player.
- 8) Use EU-standard screened cables and sockets.
- 9) Do not move the media player during the disc playback, since there is probability of damage of optical drive and internal parts.
- 10) Do not place any items on the player. The device needs some space for releasing of heat produced during its operation. DO NOT place any liquid-containing vessels, metallic items and any other materials upon its top enclosure that may disturb the normal operation of the device.
- 11) Do not hinder the opening of the tray of the media player. If something hinders the tray opening, remove it and try again.
- 12) Please remove the disc out of the player after viewing and turn off the player.
- 13) Do not press the disc tray. Do not place any items on the tray.
- 14) Voltage fluctuations in AC mains may result in improper operation of the device. In this case, please turn off the player with the POWER button on the front panel of the device or unplug, and after 10 to 15 seconds plug in back. The media player will restart, and its functionality will be restored.
- 15) If you intend not to use the Blu-ray media player for a long period of time, for safety reasons and to spare power, please make sure to unplug from the AC mains. Please be aware that even in standby mode the device consumes the power.

## Remote Control (RC)

- 1) Command indicator (i.e. indicator of remote control response to button pressing)
- 2) **EJECT, MUTE, POWER** – opening/closing of disk tray, sound on/off and standby mode on/off, respectively
- 3) **A(Red) - INFO, B(Green) - ZOOM, C(Yellow) - MODE, D(Blue) - SETUP** – control menu buttons for setting of internal functions, as well as some playback modes.
- 4) **0 - 9** – numeric buttons. Allow controlling of player in playback mode, as well as text entry.
- 5) **INFO, ZOOM, MODE, SETUP** – control menu buttons, allow setting of internal functions, as well as some playback modes.
- 6) **Vol+ / Vol-** – volume adjusting
- 7) **Page Up / Page Down** – for scrolling up and down to see and change settings.
- 8) **SUBTITLE, AUDIO, RETURN, POP UP/MENU, ENTER** and control menu buttons **UP, DOWN, RIGHT, LEFT** – to control main player modes and cursor motions through file browser.
- 9) **PLAY, PAUSE, STOP, REW, FWD, PREV, NEXT, SLOW REW, SLOW FWD** – media file playback control buttons.
- 10) **TOP MENU/URL, ANGLE/ROTATE, SEARCH** – control menu buttons, allow setting of internal functions, as well as some playback modes.

*\*Some buttons may have several functions, depending on mode. For more details visit: <http://www.HDI.co.il/manuals>.*

### Note:

- Use alkaline AA batteries.
- Observe polarity when inserting batteries.
- Direct the remote control to the player. There must be no obstacles between the RC and the player. If the player is installed inside a desk with tinted glass, the manufacturer may not guarantee an undisturbed functioning of RC.
- If RC functions only at short distances or stopped functioning, make sure to replace batteries to new ones.

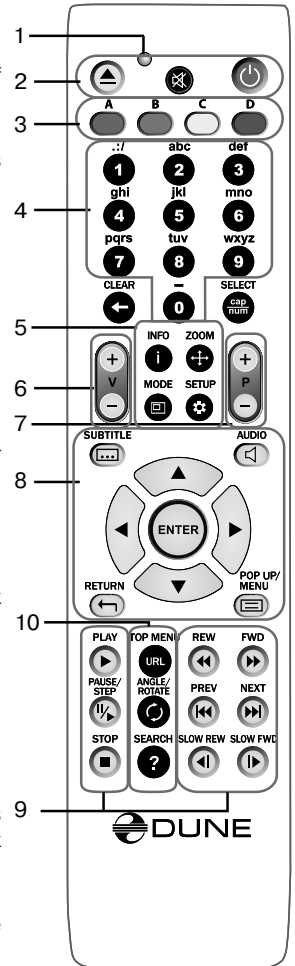

## Effective distance of the remote control transmitter

### Note:

- When there is an obstacle between the player and the transmitter, the transmitter may not operate.
- When direct sunlight, an incandescent lamp, fluorescent lamp or any other strong light shines on the REMOTE SENSOR of the Player, the remote operation may be unstable.

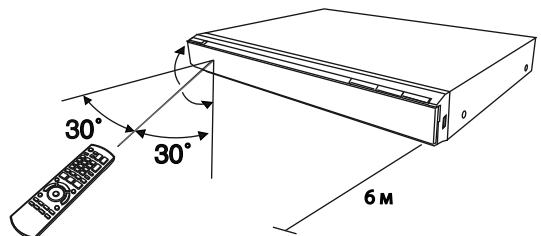

## Before getting started

When you start using the media player for the first time, please make sure that the shipping packing is not broken, has no compression or opening marks.

- If the packing was broken, the manufacturer shall not be held liable in respect of the integrity of the package contents.

When you connect the media player to your AV appliances for the first time, please make sure that all seals and retainer screws on the top enclosure are in place and contain no unsealing mark.

- If for some reason, the seals were broken, the manufacturer shall be entitled to refuse the free of charge after-sales servicing of the device.

After switching on the player performs automatic booting procedure, including boot-up of embedded operating system. It may take 30 to 60 sec. After that you will get to splash screen (Main root folder) of the file browser.



**Please do connect to relevant AV appliances only if all devices are switched off.**

## Quick setting of video output

**MODE button on the RC allows quick setting of video output without use of setup menu. This type of video output configuration may be required in case that after connection of your player to a TV or projector, you see no picture on screen (and no setup menu displayed accordingly).**

After pressing **MODE** button you will enter quick setting mode of video output. Pressing one of the digit buttons **1, 2, 3, 4, 5** right after that on your RC, you may switch to one of the following settings of video output respectively:

1. Composite/S-Video/Component, **PAL**
2. Composite/S-Video/Component, **NTSC**
3. HDMI, **480i** 60Hz
4. HDMI, **720p** 60Hz
5. HDMI, **1080i** 60Hz

To exit quick setting mode of video output after successful settings, press **ENTER** on your RC.

- After pressing the **MODE** and a digit buttons please wait for up to 15 sec. before the new video mode is settled.
- The pointed five video settings are only to ensure that you can quickly set up some usable video mode for any type of video connection you are using, regardless the previous settings of your player.
- After getting picture on screen with one of these modes, please go into **Setup** menu and choose the most appropriate video output and resolution.
- During any video playback the **MODE** button is deactivated. To change parameters of video output, stop playing back by pressing **STOP** button.
- In case of any problems, to make sure that the playback is stopped and you are in file browser mode, switch **Off** and then switch **On** the player and wait until player booting during up to 60 sec.

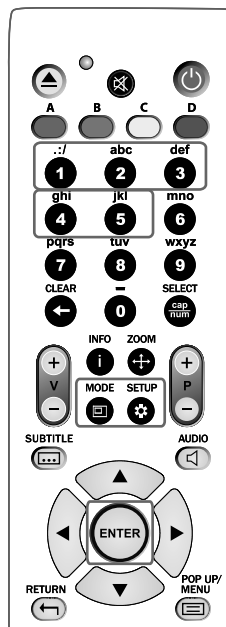

## Notes on Discs



The regional code of BD-DVD discs is shown on the rear panel of your player.



## Information on regional content protection:

This media player has been developed and manufactured under Region Management Information conditions available on the disc. If the regional code shown on BD-DVD disc does not match the regional code of this player, this device will not play back this disc. You will not be able to play back some BD-DVD disc with this media player, if they were bought outside your home region or intended not for in-home use.

## Notes on Copyright:

The law prohibits copying, transmitting, displaying, broadcasting via cable network, public playback and letting on lease of copyright-protected materials without the rightholder's authorization. The video discs are encoded with copy protection, and any picture recorded from this disc will be distorted. This product incorporates a copyright protection technology which is protected by requirements of certain U.S. patents and other intellectual property rights owned by Macrovision Corporation and other rights owners. Use of this copyright protection technology must be authorized by Macrovision Corporation and is intended for home viewing uses. Reverse engineering or disassembly is prohibited.

## Restrictions in respect of content playback

When playing some BD-DVD-CD disks, some operations, commands and functions may not be available. It is connected with the software features recorded on the media. This feature is not a trouble.

Although the player supports the majority of the most common file formats (containers and codecs), it does not mean that it will play any files. It is not guaranteed that this media player will play without fail absolutely all Blu-ray, DVD and CD labeled discs either. It is due to possible faults during recording of these discs: software errors or poor quality of the optical drive. Frequently media files are recorded with violation of certain rules, and although they may be properly played with some built-in PC players, this media player may not be able to do this (play back these 'exotic' files). These restrictions and errors may be potentially eliminated in new updates of firmware. Please refer to the 'Specifications' section for the full list of optical media and supported audio and video codecs.

## Connection to a TV set with HDMI/DVI output:

Since Dune BD Prime is designed first of all for playback of high definition (HD) video (up to 1080p), the best way of signal transmission from player to a TV set or projector is the HDMI interface. In this case, video and audio streams are transmitted in digital form, without losses, allowing enjoying excellent picture and sound. It is recommended to connect the player to any compatible equipment using original DUNE HDMI cable (option).

✓ If your TV set has no HDMI socket, but it is equipped with DVI one, you can use an original DUNE HDMI-DVI adapter (to be connected to HDMI-HDMI cable) or Dune HDMI-DVI cable (no adapter needed). In this case, transmission of audio stream is only available separately, from an analog audio or digital optical output.

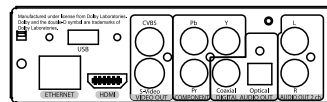

- 1) Make sure that the player and the TV set are switched off. Do not switch on until the end of connection procedure.
- 2) Connect the HDMI output of the player with appropriate HDMI/DVI input of the TV set using a HDMI-HDMI cable for HDMI input of your TV set, or HDMI-DVI cable or HDMI-HDMI cable with HDMI-DVI adapter, for DVI input of your TV set.
- 3) Using RC of TV or projector (depending on what you use), select required input and display mode. For more instructions please refer to the manual of your displaying equipment.
- 4) Wait until you see a picture on screen of your TV (or projection) set received from the player.

## DUNE BD Prime specifications

Optical discs support	BD-ROM, BD-R (RE), DVD-ROM, DVD-R (RW), CD*, CD-R (RW)
Video file formats	MKV, MPEG-TS, MPEG-PS, M2TS, VOB, AVI, MOV, MP4, QT, ASF, WMV, DVD-ISO, VIDEO_TS
Video compression algorithms	MPEG2, MPEG4, DivX, XVID, WMV9, VC1, H.264
Audio formats**	DD: AC3 (DD), EAC3 (DD+), Dolby True HD [lossless]; DTS: DTS HD High Resolution Audio (HRA), DTS HD Master Audio (MA) [lossless], decoding in PCM/analog, Bitstream on HDMI1.3.
Digital images***	JPG, PNG, BMP
Subtitle formats	Plain text, SSA/AAS (MKV containers), SRT (with any supported video file format), VOB
Processor	Sigma Designs 8634 SoC
System memory	RAM: 384 Mb ROM: 64 Mb (for control microprogramm) 1GB NAND flash
Available picture modes through HDMI v1.3	<ul style="list-style-type: none"> <li>• 480i, 480p (60 Гц) • 576i, 576p (50 Гц) • 720p (50 Гц, 60 Гц)</li> <li>• 1080i (50 Гц, 60 Гц) • 1080p (24 Гц, 25 Гц, 30 Гц, 50 Гц, 60 Гц)</li> <li>• 1024x768, 1280x1024, 1280x768, 1280x960, 1360x768, 1366x768, 1400x1050, 1440x900, 1600x1200, 1680x1050, 1920x1200 (60 Гц)</li> </ul>
Analog video output	Component (Y, Pb, Pr), S-Video, composite (CVBS)
Audio output	Digital: optical Toslink and coaxial, analog: 7.1 output and stereo 2RCA
USB 2.0 ports	3 x USB Host
LAN connection	LAN Ethernet 100 Mbit/sec Wi-Fi (optional; using USB accessory)
Size, cm	430mm (width) x 270mm (depth) x 45mm (height)

\*playback of CD function will be added in one of following firmwares.

## DUNE BD Prime dimensions

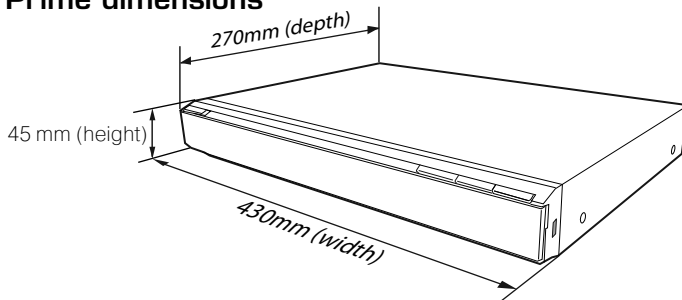

\* Note: Files with specific coding features or specific combinations of containers/codecs may not be played, or played with limitations or improperly. Follow release of firmware updates (control micro-programs). Firmware update may resolve problems of playback of some files. This procedure may be made by the user or by a technician of post-sales service center.

\*\* Note: basic modes of music files playback are currently supported (single file playback, M3U and PLS play lists are supported). More advanced mechanisms will be available in future firmware releases.

\*\*\* Note: only very basic mode of picture viewing is currently supported (single picture view only). More advanced mechanisms, including slide shows, will be available in future firmware releases.



[www.HDI.co.il](http://www.HDI.co.il)



*To get the full version of the instruction please visit:*

**<http://www.HDI.co.il/manuals>**

